

WELLS Counter Point

Volume 3 Issue 1, January 1999

THE ELECTRONIC, DIAGNOSTIC AND DRIVEABILITY RESOURCE.

Understanding Hall Effect Sensors

Hall Effect Sensors are used in many ignition

system distributors to trigger the primary circuit (fire the coil) and to monitor engine rpm.

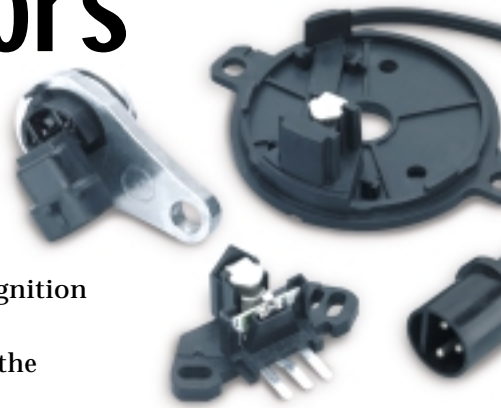

But they are also used in many distributorless ignition systems (DIS) to determine the position of the crankshaft and camshaft. This is because the engine computer needs to know where the number one cylinder is as soon as the engine is cranked. As soon as the all-important "sync-pulse" is detected, the ignition module can start firing the plugs in the correct sequence. This also allows injector timing to be matched to the firing order in engines with sequential fuel injection.

Hall Effect Sensors are sometimes referred to as "switches" rather than sensors because of the on-off "digital" voltage signal they produce. Unlike magnetic sensors that produce an alternating current (AC) signal which varies in voltage with speed, Hall Effect Sensors produce a constant voltage signal that can change abruptly from maximum voltage to nearly zero and back again regardless of engine speed. This produces a square wave output signal that can be easily used by the onboard computer for timing purposes.

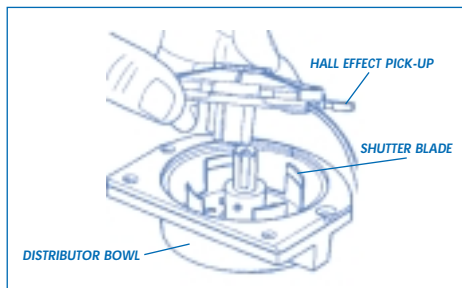

INNER WORKINGS

A typical Hall Effect Sensor has three wires or terminals: one for ground, one for supply or reference voltage and one for the output signal. To produce an output signal, a Hall Effect Sensor must be supplied with a reference voltage from the vehicle's onboard computer (which may be 5 to 12 volts depending on the application). The supply voltage is necessary to create the switching effect that takes place inside the sensor.

The operating principle upon which Hall Effect Sensors are based (and so named) dates

continued on page 2

WELLS Earns QS-9000 Status at all Facilities

WELLS Manufacturing Corp. has earned QS-9000 quality compliance at all four of the company's facilities.

"QS-9000 is the toughest quality standard in the automotive industry," said WELLS' President William Allen. "For WELLS to earn the recognition companywide assures our customers that they are getting the best parts backed by the best service available."

QS-9000 is a stringent and uniform quality standard established by the Big Three automakers to ensure that all their suppliers meet the highest quality standards.

Achieving and maintaining QS-9000 status is a demanding process, which can take thousands of man hours of preparation. Companies must undergo twice-a-year audits to maintain the quality certification.

WELLS in 1996 became the first and thus far only full-line manufacturer of ignition components to earn QS-9000 compliance for the manufacture of electronic engine management systems, charging systems and sensors.

This year, WELLS also earned QS-9000 compliance for its second manufacturing facility in Fond du Lac, Wisconsin, one in Reynosa, Mexico and its distribution complex in Centerville, Iowa.

Requests for Subscriptions Top 25,000

In its first year, WELLS Counter Point quarterly newsletter generated more than 25,000 subscription requests from technicians.

"We started Counter Point to provide additional support for technicians," said Gavin Spence, WELLS' vice president of sales. "We're gratified that so many of them have found it a valuable informational tool."

Anyone wanting a new subscription should fill out the form on Page 4 of this issue. Those who already subscribed will automatically receive future issues.

Understanding Hall Effect Sensors

back to 1879 when Edwin H. Hall, an American scientist, discovered a new electrical phenomenon. When he applied an electric current to a piece of metal inserted between two magnets, it created a secondary voltage in the metal at a right angle to the applied voltage. The discovery didn't have much practical use at the time, but it turned out to be just the thing that future engineers would need to create a switching device capable of producing an efficient on-off square-wave voltage signal. The Hall Effect was adapted so the voltage change would occur in a silicone chip placed at a right angle to a magnetic field.

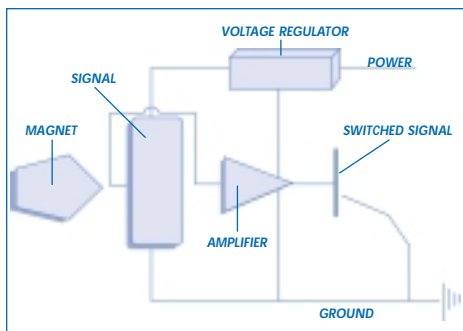

When a metal blade passes through the air gap between the magnetic field and silicon chip, it blocks the magnetic field and causes the chip's output voltage to suddenly drop to zero. With additional circuitry, the sensor can be made to do just the opposite: to produce a voltage signal when the blade enters the magnetic field. Additional circuitry regulates the supply voltage to the chip and amplifies its voltage output. In an automotive ignition system, shutter blades are mounted on the distributor shaft, rotor, crankshaft pulley or cam gear so the sensor can generate a trigger and/or position signal as the crankshaft rotates. In some applications, a notch in a pulley, a gear tooth or even a rotating magnetic button serves the same purpose as the shutter blade to disrupt the sensor's magnetic window and trip the switch.

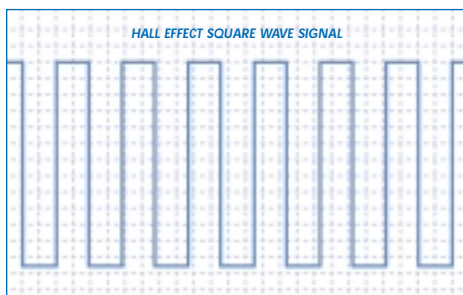

A Hall Effect Sensor may be normally "on" or "off" depending on how its circuitry is designed. The normally "on" variety (such as GM crank position sensors) produces a steady

voltage output when the magnetic window is unobstructed and no blades are passing through it. The voltage output drops to near zero when a blade enters the magnetic window and blocks the field. The Profile Ignition Pick-up (PIP) and Cylinder Identification (CID) Hall Effect Sensors found in Ford distributorless ignition systems work in the opposite manner. When the shutter blade passes through the window and blocks the magnetic field, the sensor's internal electronics switch the sensor's output signal from near zero (off) to maximum voltage (on).

TROUBLESHOOTING

Sensor problems can be caused by wiring faults, loose or corroded connectors, or arcing that damages the internal electronic circuitry. There are several ways to troubleshoot Hall Effect Sensors. One is to use a self-powered "indicator light" type of Hall Effect Tester that flashes when the sensor's output signal changes. If the sensor is being tested on the vehicle, simply plug the tester into the sensor, then crank the engine and observe the indicator light. It should wink on and off while the engine is cranking. If the sensor is being tested off the vehicle, plug the tester into the sensor connector and observe the indicator light. It should remain on steadily. Then insert a metal blade into the sensor's magnetic window (air gap). The indicator should go off while the blade is in the window, then wink back on when the blade is removed. No change would indicate a faulty sensor.

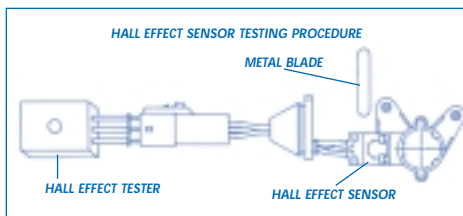

On-car sensor problems can be caused by several things:

- The sensor must have the proper reference voltage (VRef) power supply from the computer. If the sensor is not receiving the required voltage, it won't work. Measure the supply voltage between the sensor's power supply wire and ground (use the engine block for a ground, not the sensor's ground circuit wire). If you don't see the specified voltage, check the sensor's wiring harness for loose or corroded connectors.
- The sensor's ground circuit must be in good condition. A poor ground connection will have the same effect on the sensor's operation as a bad VRef supply. Measure the voltage between the sensor's ground wire and the engine block. If you see more than 0.1 volts, the sensor has a bad ground connection.

If the sensor has power and ground, the next thing to check would be sensor output. The voltage output signal should switch back and forth from maximum to near zero as the engine is cranked. No change would indicate a faulty sensor. Watching the sensor's voltage output on an oscilloscope is a good way to spot problems that might escape normal diagnosis. You should see a nice, sharp square wave pattern that goes from maximum to near zero (or vice versa) every time the sensor switches on and off. The "sync" pulse signal from a crank/cam position sensor should also stand out and be readily apparent in the waveform. If you see rounded corners, spikes, excessive noise or variations in amplitude from one pulse to the next, the erratic operation of the sensor may be causing the computer to miss signals or pick up false signals.

In the case of cam/crank sensors, the Hall Effect Sensor must be properly aligned with the interrupter ring or shutter blade to generate a clean signal. A worn or stretched timing chain as well as "cam walk" can affect the sensor's output. Any contact between the moving parts and sensor can cause idle problems as well as sensor damage. A failure of a crank position sensor usually causes the engine to quit because the reference signal for the ignition and fuel injectors is lost.

If you're testing an electronic ignition system with a Hall Effect Pick-up in the distributor, you can insert a steel feeler gauge or pocket knife blade, etc. into the sensor window to see if it fires the ignition coil. Blocking the magnetic window in a Hall Effect Sensor should have the same effect as opening the points in a breaker point ignition system. Don't forget to turn the ignition switch on before making this test. Also, make sure the spark has a proper path to ground via a spark gap tester.

On older Chrysler Hall Effect Ignition Systems, the shutter blades under the rotor must be properly grounded to produce a clean signal. Use an ohmmeter to check continuity between the shutter blades and distributor shaft. If the blades are not grounded, the sensor will check out ok but won't produce a good signal when the engine is cranked with the rotor in place. On Ford applications with Thick Film Integrated (TFI) ignition distributors, the Hall Effect Signal is called the "Profile Ignition Pick-up" (PIP) signal. Corroded connectors between the Hall Effect PIP unit in the distributor and the TFI module on the distributor housing are common. Replacing the sensor isn't as easy on these applications because you have to R&R the distributor shaft.

Fine Tuning



Fine Tuning questions are answered by Jim Bates, Technical Services Director. Please send your questions to: Jim Bates c/o WELLS Manufacturing Corp., P.O. Box 70, Fond du Lac, WI 54936-0070 or e-mail him at technical@wellsmfgcorp.com. We'll send you a WELLS shirt if your question is published. So please include your shirt size with your question.

Q: "We have a 1994 Pontiac Grand Am with a 3.1L. This vehicle has an intermittent increase in rpm at idle. We've checked vacuum, timing, sensors and IAC operation. All seem OK except for an occasionally low reference voltage. Replacing the computer did not cure the reference voltage or idle problem. Any ideas?"

Eldridge Bros., Independence, KS

Check the circuit supplying the 5-volt reference. If a large current draw flows through this circuit, the input signals as read by the ECM will be skewed low. The ECM will store an incorrectly low TPS signal. When or if the reference signal returns to normal, the ECM will interpret the new TPS signal as an open throttle indication and the IAC steps will be increased accordingly, causing a high idle speed. The A/C pressure transducer circuit has been known to be especially vulnerable to shorts during cranking on this vehicle. Other wiring in the engine compartment that is unprotected and rubs against grounded surfaces can also cause this kind of problem.

Q: "I have a low fuel pressure problem on a 1998 Hyundai Excel with a 1.5L 8-valve engine. I replaced the pump, checked the filter, power and ground. What am I overlooking?"

Webber Auto, Philadelphia, PA

Whenever the fuel pump is replaced, be sure you check the fuel pump hose for signs of cracking or pinholes. Inside the fuel tank on these vehicles, a rubber hose serves as the fuel passage between the fuel pump motor and the fuel pump assembly mounting plate. If this hose becomes cracked or develops pinholes, low fuel pressure will result. Maximum fuel pressure may drop to the 20-25 psi range.

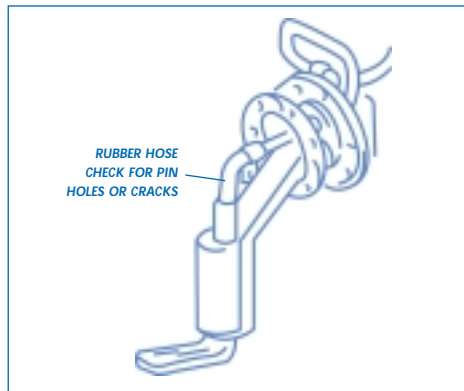

Q: "I'm sure you've probably encountered this before, but nobody around here seems to know how to solve this problem short of distributor replacement: 1988-1991 Toyota Camry 2.0L 16-valve engine; bucking and hesitation, often hard or no start, particularly in damp weather. Some reports of hard start even in better

weather after sitting, say, over the weekend. Cap, rotor, ignitor replacement doesn't solve the problem."

Plainfield Auto Sales, Plainfield, CT

Actually, the condition you described has been encountered before and in each case the culprit turned out to be distributor bushing wear. The reddish-brown dust that is created when the bushing wears is conductive and when it gets damp it can cause the type of problems you have experienced. Replacing the distributor cap and rotor, and blowing the dust off of the other distributor components, including the coil cover, should restore satisfactory performance as long as the distributor shaft side play is not excessive.

Q: "I have a 1993 Oldsmobile Achieva with a 2.3L VIN C engine that only runs on two cylinders after a cold start-up. After the engine warms up, it seems to run normally. Ignition components including spark plugs (first thing I checked), fuel pressure and delivery, compression, vacuum, all check OK. What's missing here?"

Steve's Garage, Keil, WI

You didn't mention if you checked and pressure tested the cooling system. In some cases, a small crack in the engine block or cylinder head can allow coolant into one or more of the combustion chambers. After the engine has warmed up, the crack can seal and normal combustion can resume. Naturally, you will want to do your checking when the engine is cold.

Quality Points

WELLS' Training Seminars for Technicians

WELLS Manufacturing Corp. is offering technical training seminars on Advanced Engine Performance Diagnostics as well as five-gas and scan tool interpretation through sponsoring jobbers throughout North America. These classes are offered to professional technicians only, and are led by

instructors who hold L1 ASE certification, are qualified by the Council for Advanced Automotive Trainers (CAAT) and are members of the Society of Automotive Engineers (SAE). The in-depth seminars include isolation diagnostics handouts, worksheets and practical tips for

solving today's engine performance problems. See your local jobber for details.



WELLS

WELLS MANUFACTURING CORP.
P.O. Box 70
Fond du Lac, WI 54936-0070

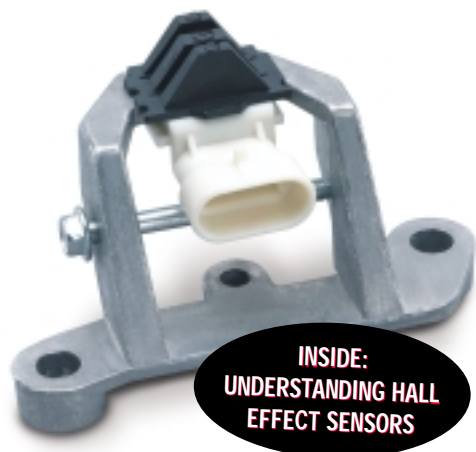

Hot off the Wire

WELLS Expands Professional Gold™ Program

WELLS Manufacturing Corp. has added three new categories to its premium Professional Gold line of distributor caps and rotors: oil-filled coils, starter solenoids and tune-up kits.



Among the features of each new category are:

- 1 **Oil-Filled Coils**
 - increased number of wire windings for greater output voltage
 - heavy-duty insulator for longer life
 - double outer laminations for a stronger magnetic field
- 2 **Starter Solenoids**
 - high-temperature insulated wire for better heat resistance
 - nickel-plated mounting bracket for better ground
 - increased contact area on studs for higher electrical current capacity and longer life
 - heavy-duty gasket to seal out moisture
- 3 **Tune-Up Kits**
 - nickel-plated point set with copper strip for higher conductivity
 - double-plated condenser with precision windings, brass terminals and insulated multi-strand copper wire for optimum energy



Publisher's Information

WELLS' PresidentWilliam Allen
Vice President SalesGavin Spence
Technical Services DirectorJim Bates
Newsletter EditorRon Raposa

Counter Point is a quarterly publication of WELLS Manufacturing Corp., P.O. Box 70, Fond du Lac, WI 54936-0070. Letters and comments should be directed to: Ron Raposa, Counter Point Editor, 3602 Inland Empire Blvd, Suite C200, Ontario, CA 91764.

© COPYRIGHT 1999 WELLS MANUFACTURING CORP.
All rights reserved. No reproduction in whole or part is permitted without the written consent of WELLS Manufacturing Corp.
Requests should be faxed to Ron Raposa at (909) 941-0877.